



4X4 ENGINEERING

SS987HFD

**SAFARI V-SPEC SNORKEL
FORD RANGER P703 / EVEREST U704
2.0L 4cyl Bi-Turbo & 3.0L V6 Turbo Diesel Engines**



01/07/2022

Parts List

ITEM	PART NO.	DESCRIPTION	QTY
1	682-133-000	BODY - SNORKEL (SS987HF)	1
2	000-135-800	3.5" AIR RAM ASSEMBLY	1
3	682-032-000	BRACKET - UPPER MOUNTING	1
4	000-002-100	BOLT - HEX - 6mm x 1.0 x 14mm (SEMS)	2
5	000-958-625	POP RIVET - 4.8mm x 10mm (Black Anodised)	3
6	683-435-000	GASKET - UPPER MOUNTING BRACKET (Nylon)	1
7	000-110	STUD - 8mm x 1.25 x 25mm - S/S	6
8	000-311-300	WASHER - BODY - 8mm x 30mm - S/S	6
9	000-205-300	NUT - NYLOC - 8mm x 1.25mm - S/S	6
10	682-024-000	HOSE - AIR ENTRY	1
11	682-023-000	ADAPTOR - AIR CLEANER INLET	1
12	000-093-400	BOLT - B/H CAP SCREW - 4mm x 0.7 x 16mm - S/S	3
13	000-300-350	WASHER - BODY - 4.0mm x 12mm - S/S	6
14	000-223-300	NUT - NYLOC - 4.0mm x 0.7mm - S/S	3

15	000-909	CLAMP - HOSE - 80/100mm - S/S	1
16	000-910	CLAMP - HOSE - 90/110mm - S/S	1
17	682-959-000	PLUG - AIR INLET BLANK-OFF	1
18	000-987-365	CABLE TIE - 7.8mm x 365mm	1
19	000-987-178	CABLE TIE - 4.8mm x 178mm	2
20	000-987-100	CABLE TIE - 2.5mm x 100mm	4
21	682-884-000	SONOFLEX DUCTING - 70mm ID x 465mm (V6 Diesel Engine Application Only)	1
22	000-914/B	CLAMP - HOSE - SIZE 56 (BLACK)	1
23	682-017-000	TEMPLATE - FENDER	1

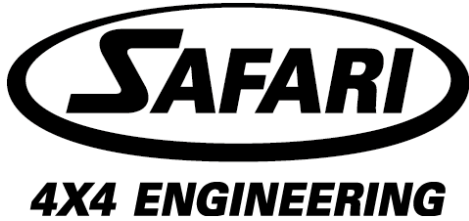

SS987HFD

SAFARI V-SPEC SNORKEL
FORD RANGER P703 / EVEREST U704
2.0L 4cyl Bi-Turbo & 3.0L V6 Turbo Diesel Engines

Installation Guide

Fitment to:

- Right Hand Side

Fitting Time:

- 210min

Special Tools:

- Body Saw (Reciprocating)
- 89mm Holesaw
- Die Grinder
- 4.5mm Long Series Drill Bit
- Step Drill and Metric Drill Bits
- Sikaflex 227 Adhesive Sealant
- Allen Key Set (Metric)
- Files
- Masking Tape
- Loctite 243 (thread lock)
- Touch-up paint

Prior to commencing the installation, it is the installer's responsibility to verify that all components and particularly the fender template (Item 23) are correct.

1

Remove the following in accordance with the factory service manual:

- Air Cleaner Assembly
- RH Mud Flap
- RH Inner Guard Liner (Main Splash Guard Section)
- RH Front Wheel Arch Moulding
- RH Inner Guard Liner (Secondary Splash Guard Section)

Hint: Cover the air intake duct with a plastic bag or rag to prevent any foreign matter from entering the engines air intake and potentially causing turbocharger / engine damage.

Caution: Extreme care must be taken when removing the Front Wheel Arch Moulding, the wheel arch moulding clip mounts are very easily broken off.

Hint: To release the plastic clips use an 8mm 1/4" drive socket and extension bar.

Optional: Remove the RH wheel arch moulding & RH Inner Guard Liner after the front fender snorkel hole modifications are complete. – See step 5

2

Remove and discard the two perforated sections from the fender template (item 23) as shown.

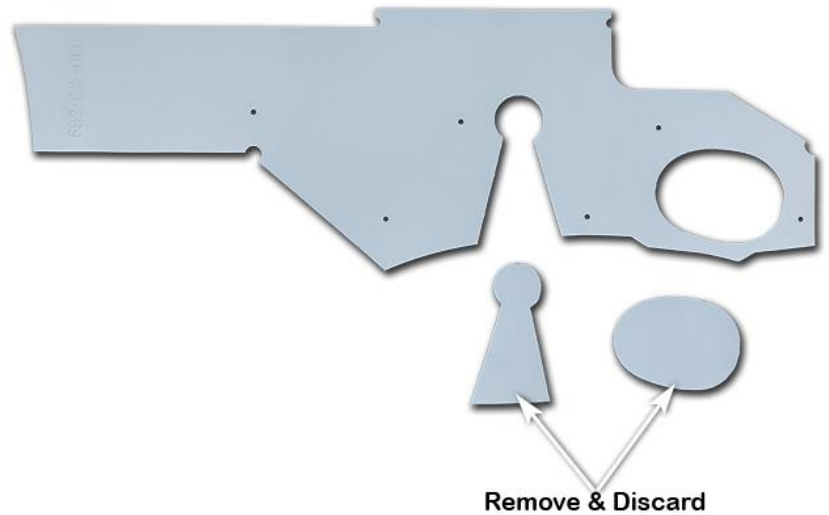

3

Align the fender template (Item 23) with the upper and rear edges of the right hand fender as shown.

Tape the template to the fender with masking tape, the template **must** follow the profile of the fender panel whilst being taped.

Mark all hole positions and the cut-out section with a felt tip pen.

Remove the fender template.

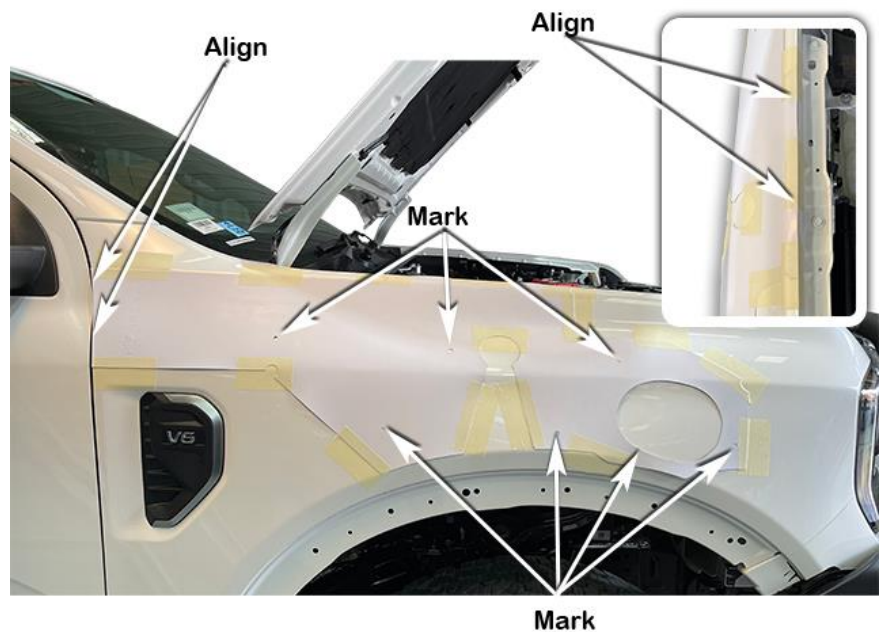

Drill a pilot hole for each of the marked hole positions.

Use a step drill to drill the six mounting holes to 16mm diameter.

Drill 1 or 2, 10mm diameter holes in the cut-out section for a start/stop point for the body saw, using the body saw cut the main hole in the fender as marked from the template cut-out in step 3, cutting on the outside of the marked cut line.

Thoroughly deburr and paint all holes and cut section of fender to prevent rust.

Caution: The drill bit length is extremely critical when drilling the pilot holes and 16mm diameter holes in the fender, the washer bottle assembly is mounted directly behind the area of the holes. **Do Not** use long drill bits.

Hint: Tape over the Fender vent and any other parts where metal swarf / filings can be trapped.

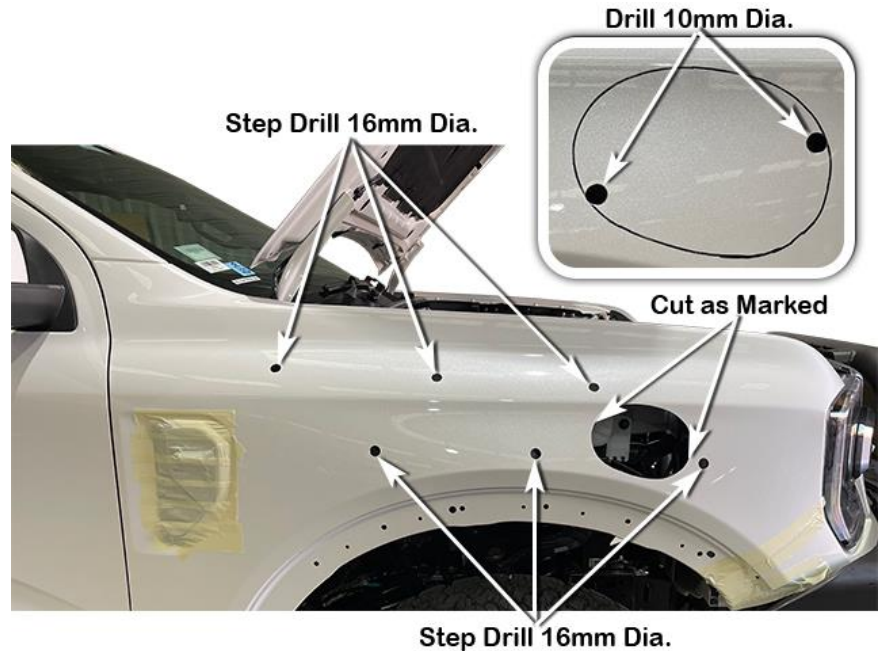

OPTIONAL: Remove the following in accordance with the factory service manual:

- RH Front Wheel Arch Moulding
- RH Inner Guard (Secondary Splash Guard Section)

Note/Caution: Extreme care must be taken when removing the Front Wheel Arch Moulding. Reach through the main hole in the fender and unclip as many of the plastic clips retaining the wheel arch moulding to the fender, carefully unclip the remaining plastic clips.

NEW ZEALAND INSTALLATIONS ONLY :

Safari have developed 2 methods of Snorkel A pillar attachment, for the conventional method please proceed with the current document alternatively please see the link below for further instructions.

www.safari4x4.co.nz/apillarmounting

6

Install the upper mounting bracket (Item 3) to the snorkel body (Item 1) with hex bolts (Item 4).

Apply Loctite 243 to each of the stainless steel mounting studs (Item 7) and install the studs finger tight into the snorkel body (Item 1) mounting inserts as shown.

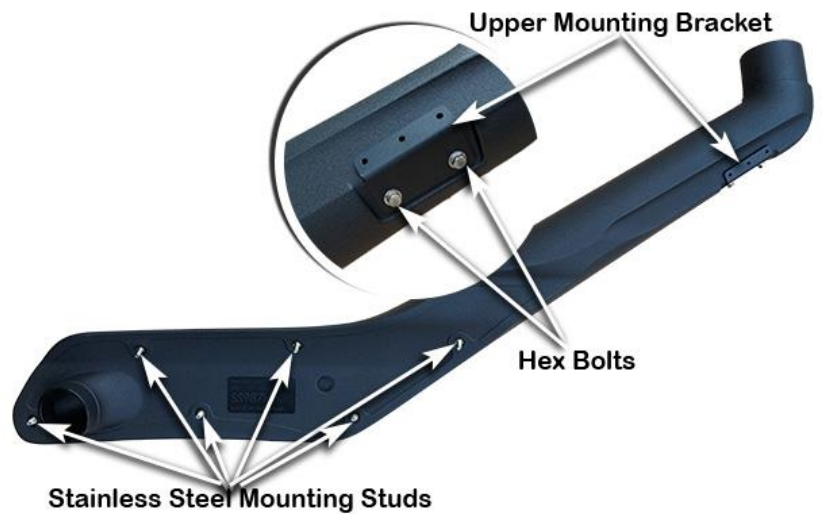

Place a strip of masking tape along the A-pillar panel.

Carefully install the snorkel body (Item 1) to the fender.

With the snorkel body correctly positioned, mark the outline of the upper mounting bracket (Item 3) onto the masking tape.

Distance from the marked line to front door edge should be approximately 10.0 - 11.0mm as shown.



Remove the snorkel body (Item 1) from the vehicle and remove the upper mounting bracket (Item 3) from the snorkel body.

Position the upper mounting bracket (Item 3) onto the A-pillar and align the bracket with the marked bracket outline.

Mark the three mounting hole positions with a felt tip pen.

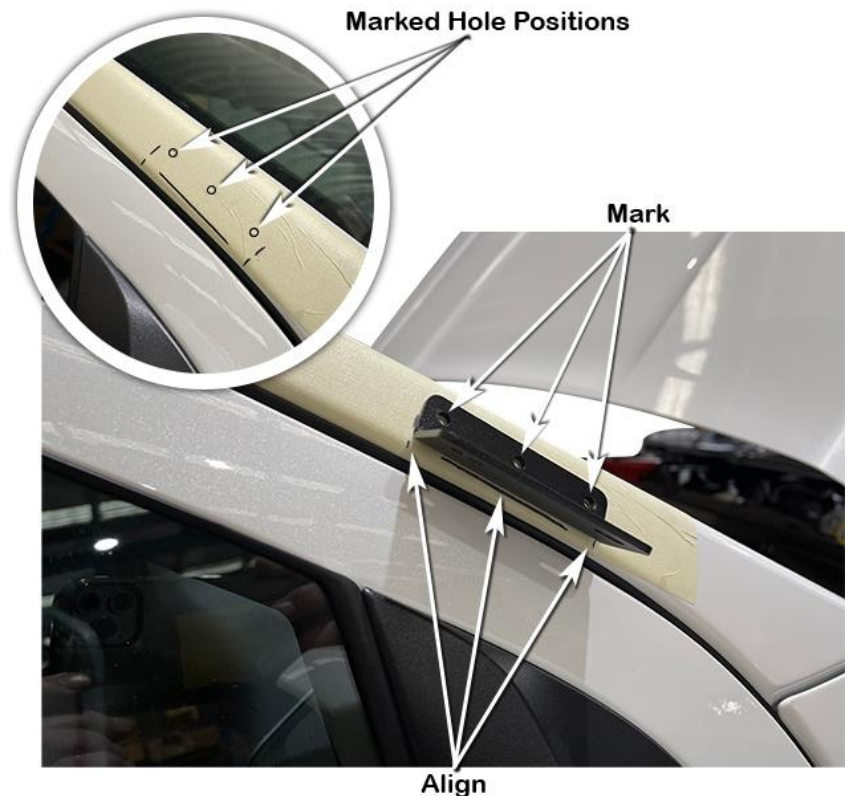

9

Drill a pilot hole at each of the three marked hole positions.

Drill each hole position to 5.0mm diameter with a 5.0mm drill bit.

Deburr and paint holes to prevent rust.

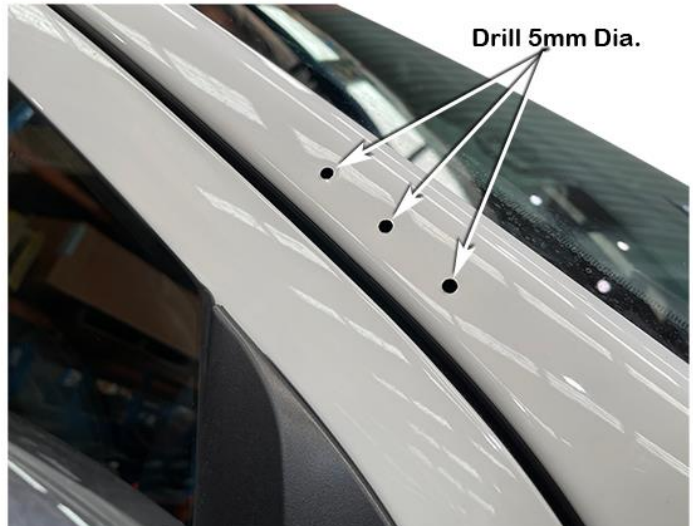

10

Install the nylon bracket gasket (item 6) to the upper mounting bracket (item 3) and install the upper mounting bracket and nylon bracket gasket onto the A-pillar.

Install the three pop rivets (item 5) through the bracket and gasket and into the three 5.0mm diameter holes in the A-pillar panel.

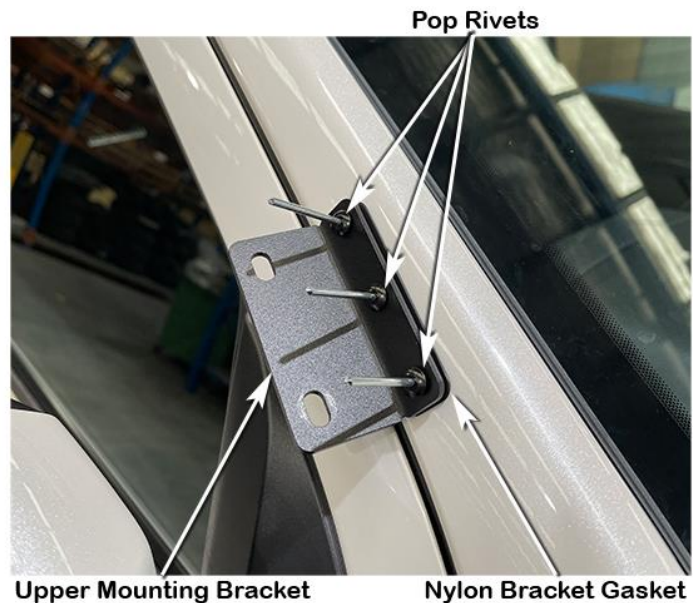

11

Using a pop rivet gun, secure the three pop rivets attaching the upper mounting bracket and nylon bracket gasket to the A-pillar panel.

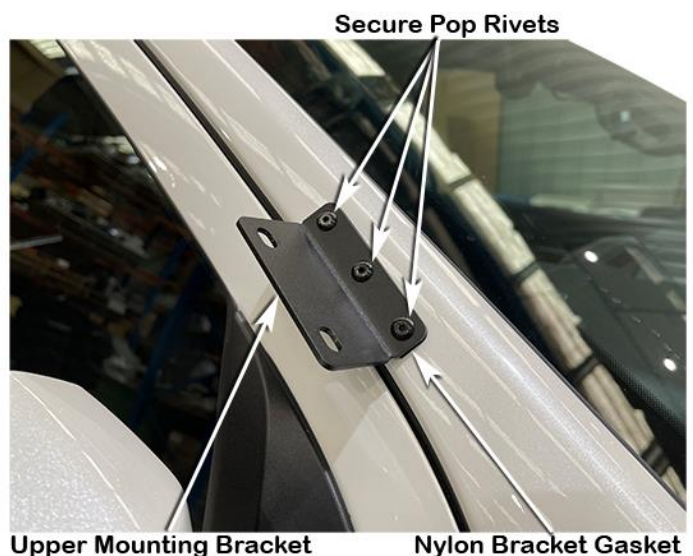

12

Remove and discard standard air cleaner Inlet Duct from air cleaner base.

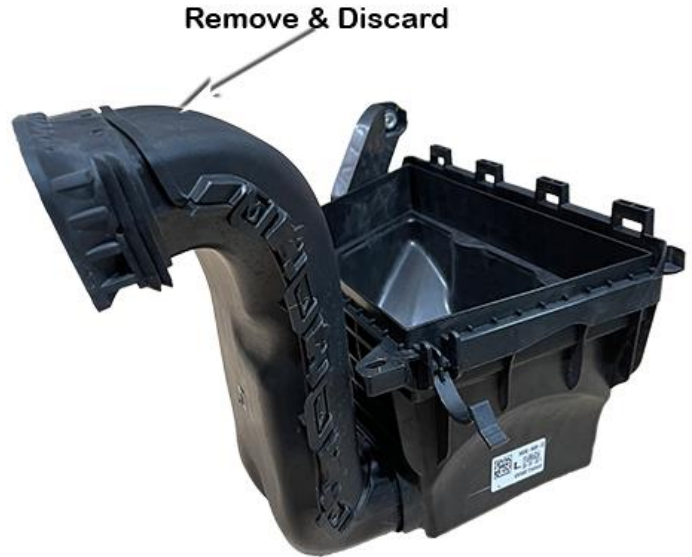

13

Using the body saw and die grinder, neatly remove the two air deflector ribs from inside the air cleaner base as shown.

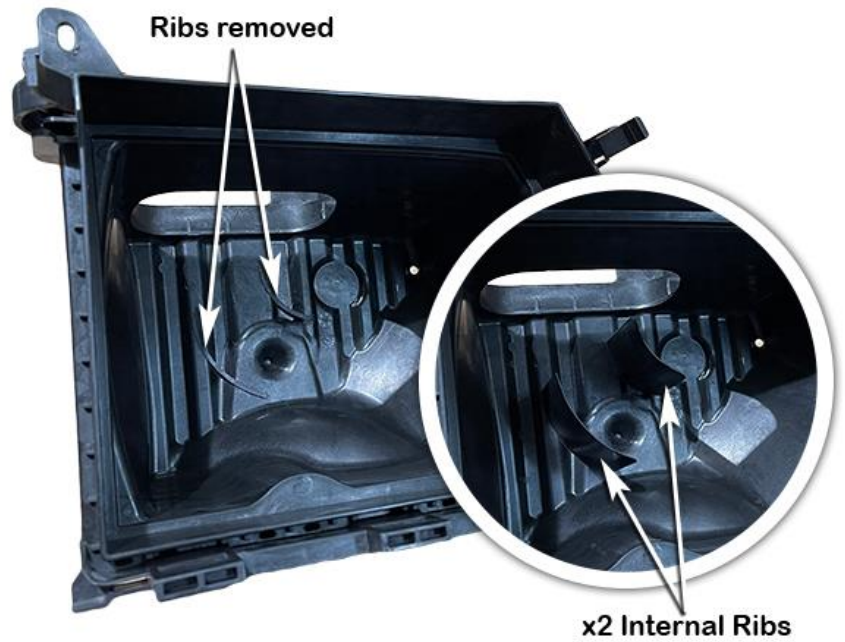

Drill a 4.5mm pilot hole through the centre mark of the blanked-off side air cleaner inlet.

Using an 89mm holesaw drill out the new air cleaner inlet hole in the side of the air cleaner base as shown.

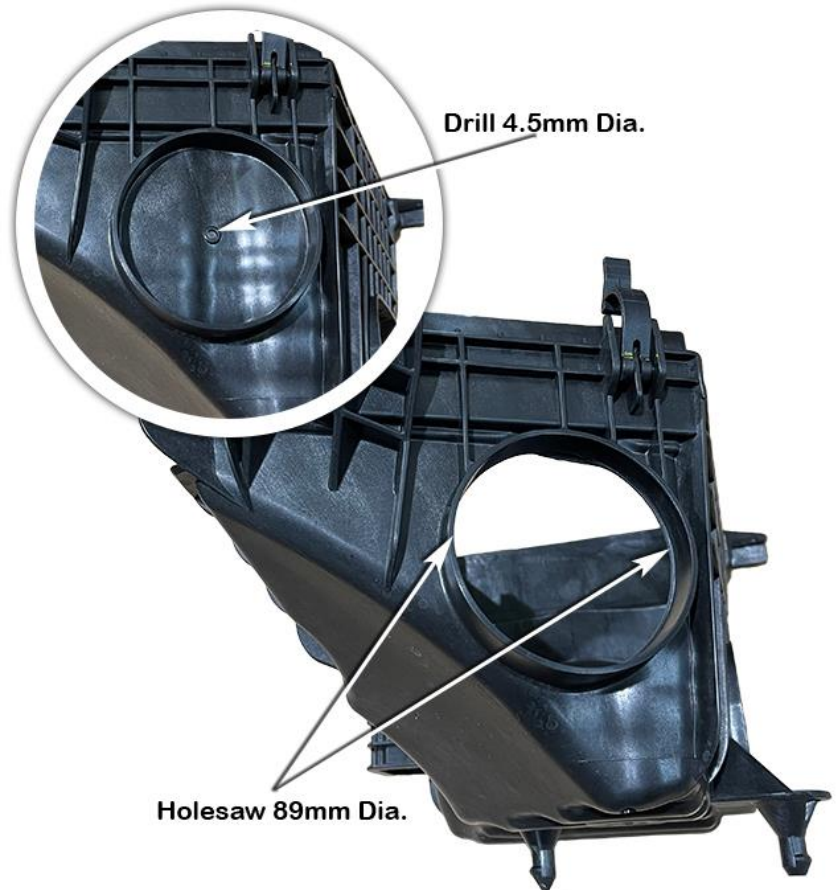

Using the die grinder and body saw, carefully remove the shown sections of ribs from the front and side of the air cleaner base around the new air cleaner inlet hole, as shown.

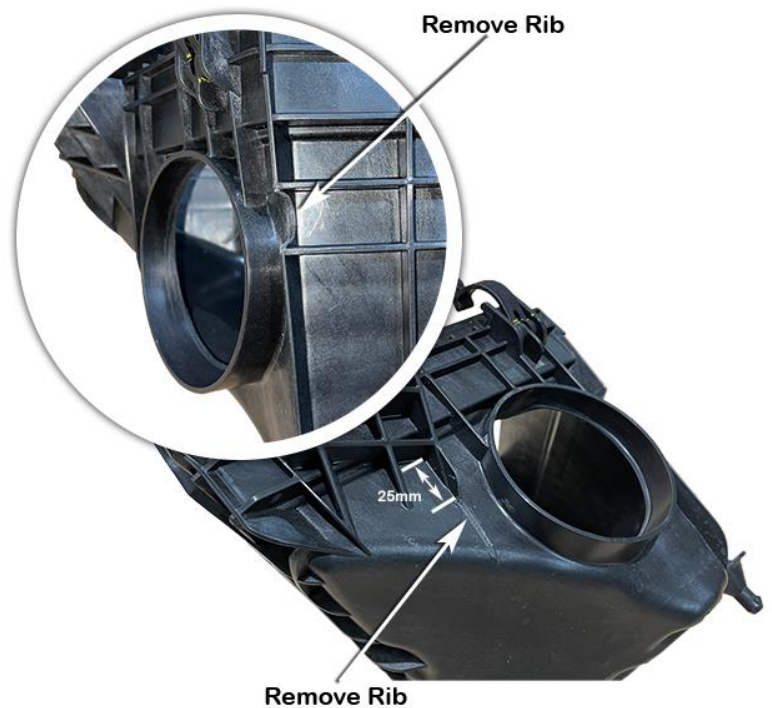

Measure and mark the three hole positions around the new air cleaner base inlet hole as shown.

Ensure the marks are positioned correctly to the specified dimensions (shown) from the end of the inlet.



Using the 4.5mm long series drill bit, drill the three 4.5mm Dia. holes through the new air cleaner base inlet as marked in step 16.

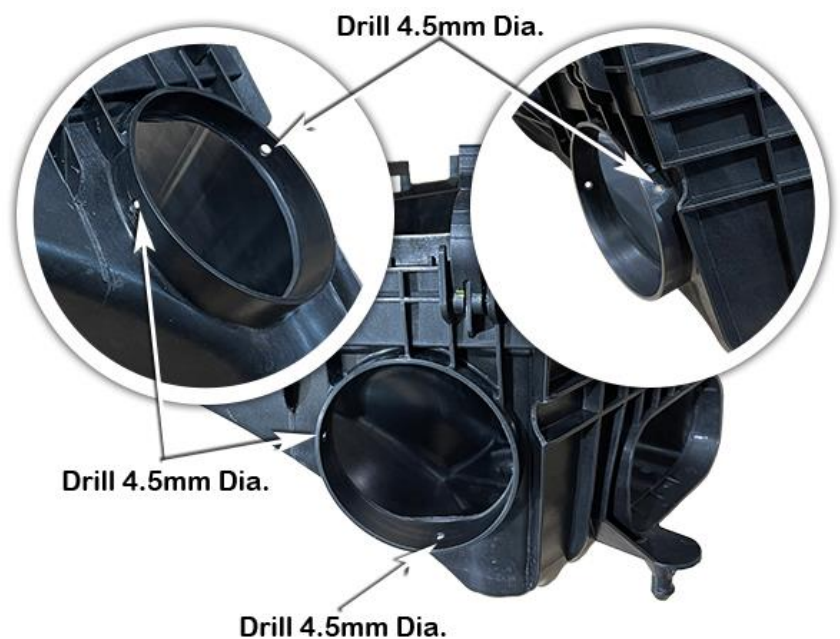

Install the air cleaner inlet adaptor (item 11) into new air cleaner base inlet.

Rotate and align the air cleaner inlet adaptor to the new air cleaner base inlet, ensure air cleaner inlet adaptor is seated flush against new air cleaner base inlet as shown.

Using the 4.5mm long series drill bit, drill the three 4.5mm holes through the air cleaner inlet adaptor (item 11).

Hint: After drilling the 1st hole fix the air cleaner inlet adaptor to the new air cleaner base inlet with a 4.0 x 16mm B/H Bolt (Item 12), 4.0mm Body Washer (Item 13)x 2 and 4mm Nyloc Nut (Item 14), before continuing to drill the remaining 2 holes.

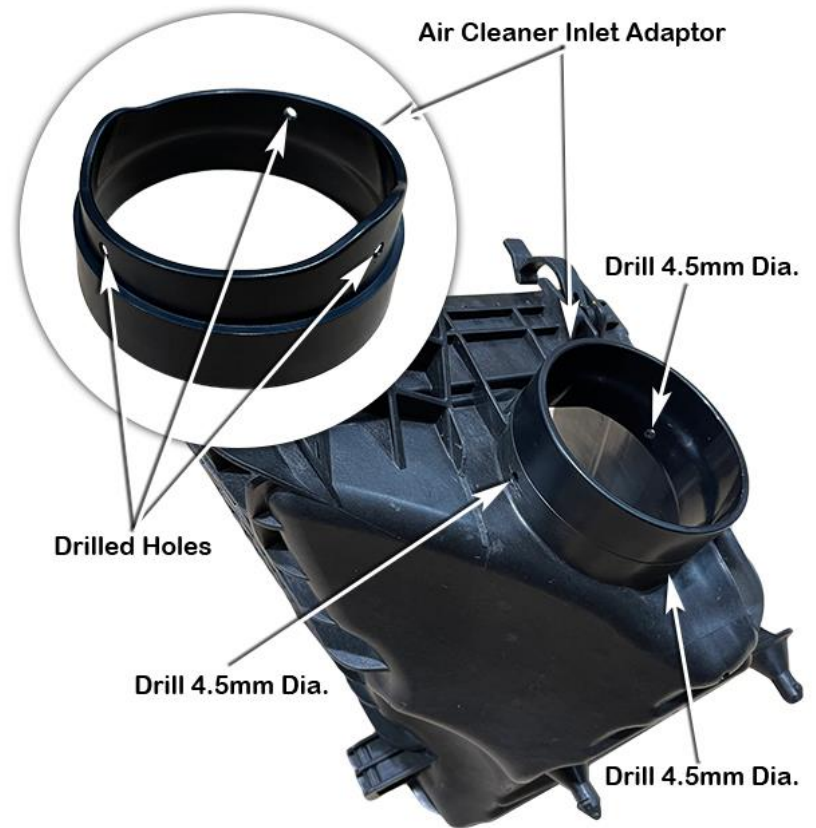

Remove air cleaner inlet adaptor (Item 11) from air cleaner base and clean both mating surfaces.

Apply Sikaflex adhesive sealant to the mating surfaces of the new air cleaner base inlet and the air cleaner inlet adaptor (item 11).

Install the air cleaner inlet adaptor (item 11) to air cleaner base and line up the 4.5mm holes.

Install the 4.0mm x 16mm B/H Bolts (Item 12), 4.0mm Body Washers (Item 13) and 4.0mm Nyloc Nuts (Item 14) as shown.

The B/H Bolts must be installed from the inside of inlet duct as shown. Tighten the three 4mm x 16mm bolts.

Clean up any excess sealant to ensure a neat finish.

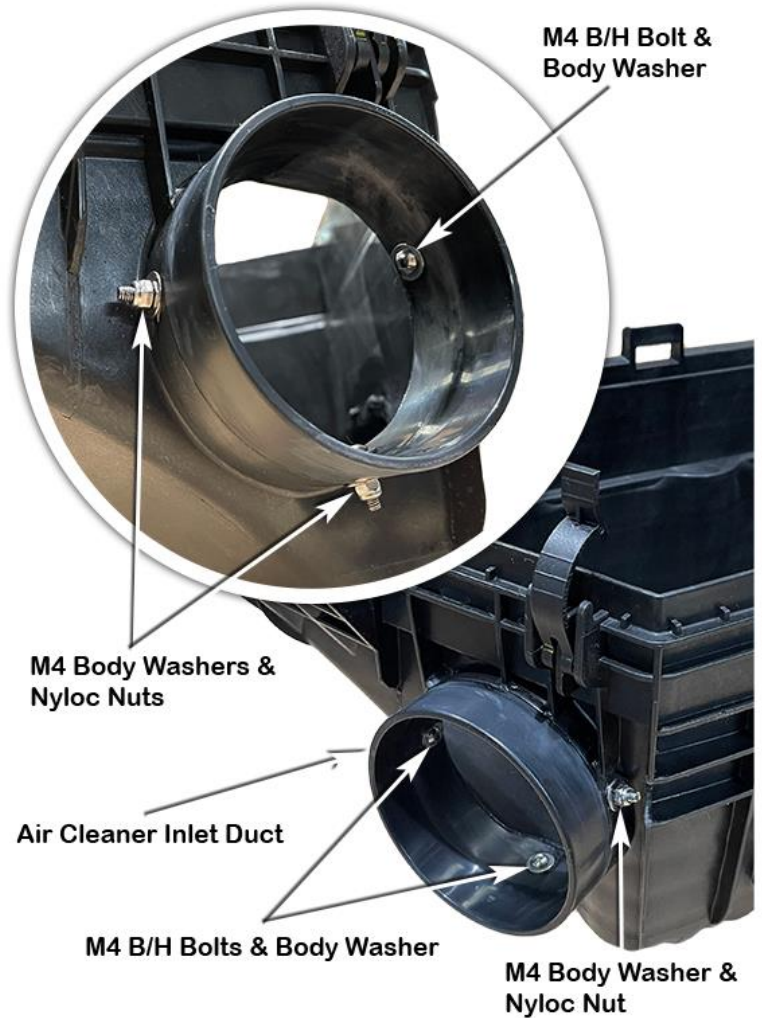

Apply Sikaflex adhesive sealant to the original air cleaner inlet hole and air inlet blank-off plug (item 17).

Install the blank-off plug into the original air cleaner inlet hole.

Ensure the blank-off plug is fully inserted into air cleaner base and blank-off plug clips are fully engaged.

Clean-up any excess sealant to ensure a neat finish.

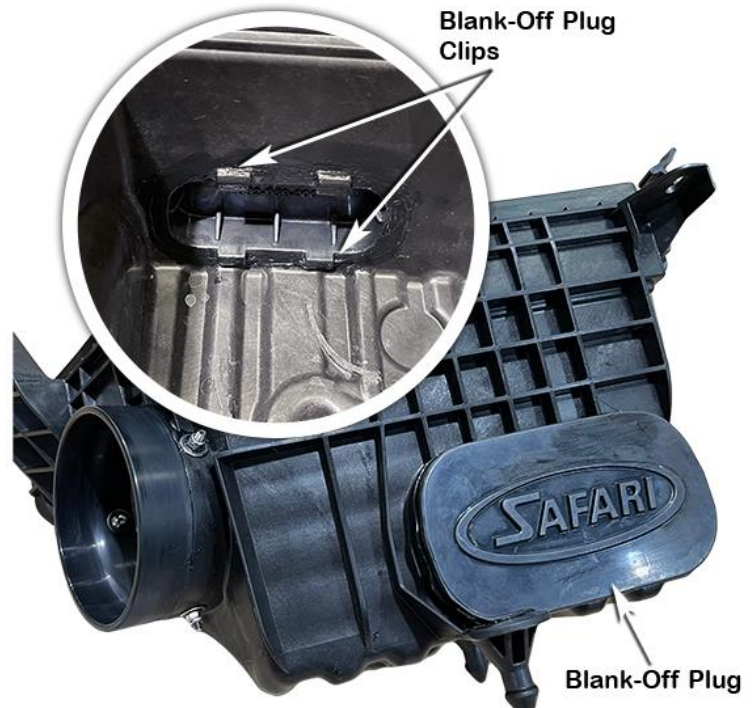

INSTALLER OPTION :

The air cleaner base contains a drain hole as shown. The drain hole can permit water to enter the air intake.

Safari advises that the drain hole should be sealed to ensure a watertight installation.

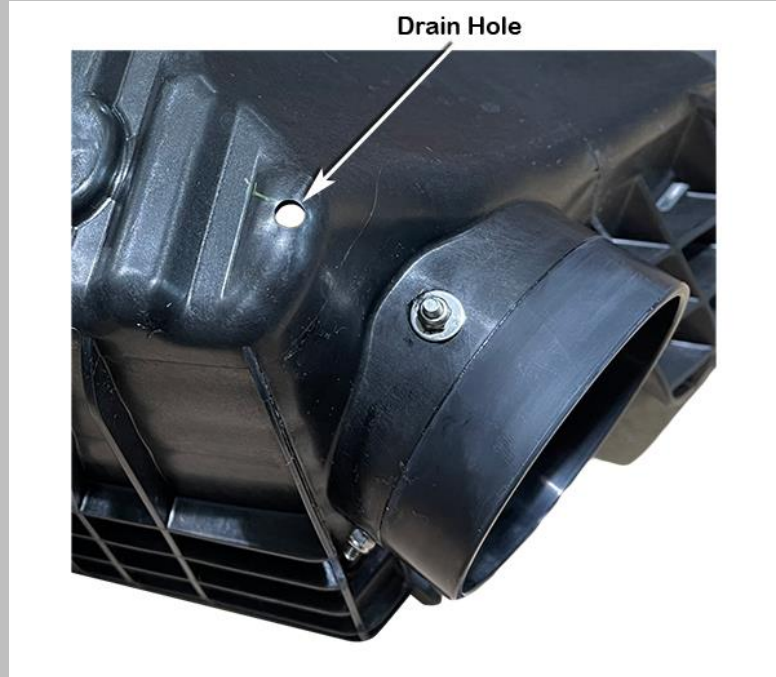

Cable tie the main loom to the vehicles top structure rail using the large cable tie (item 18) as shown.

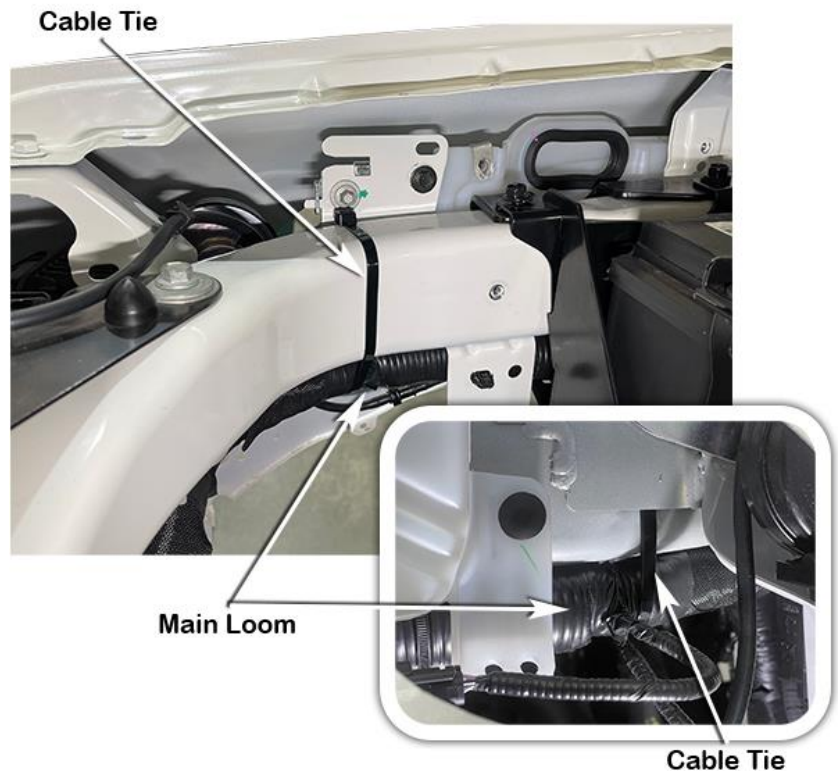

Note: Depending on the model or specification of the vehicle, the horn and washer hose may or may not be present.

Cable tie the washer hose and/or loom along the path shown using the remaining cable ties (item's 19 & 20) where required, so they do not come into contact with the air entry hose (item 10) when installed.

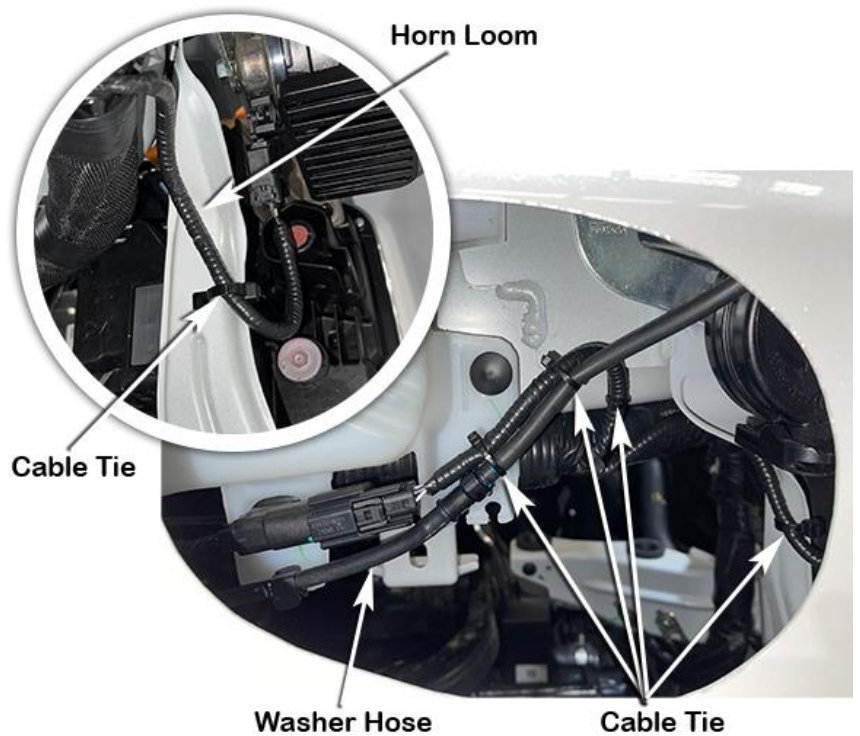

Install the air cleaner base back into the vehicle and fasten with the standard mounting bolt.

Loosely position 90/110mm hose clamp (item 16) onto air entry hose (item 10).

Install air entry hose (item 10) onto air cleaner inlet adaptor, ensure to position the air entry hose (item 10) correctly, aligning the tabs on the air entry hose with the center rib on air cleaner base as shown, tighten the 90/110mm hose clamp.

Loosely position 80/100mm hose clamp (item 15) onto air entry hose (item 10).

Note: The orientation of the hose clamps.

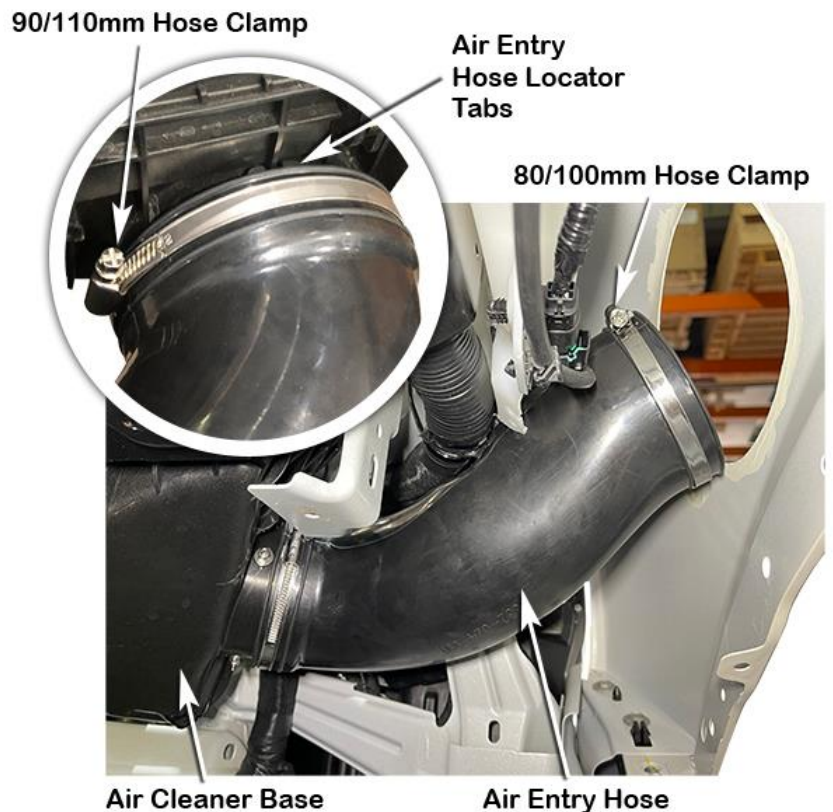

**V6 DIESEL ENGINE
APPLICATION ONLY:
SONOFLEX INSTALLATION.**

Install the Sonoflex ducting (item 21) from the air cleaner base side rotating and pushing the ducting all the way through the air entry hose (item 10) until it is positioned to the specified dimensions.

The sonoflex ducting (item 21) should protrude into the air cleaner base approximately 175mm and stop short of the air entry hose inlet by approximately 25mm, as shown.



Apply a small amount of lubricant to the inside of the air entry hose (item 10).

Carefully install the snorkel body (Item 1) to the fender, guiding the snorkel body outlet into the air entry hose (item 10), align the snorkel body to fender and upper mounting bracket.

When correctly aligned, fasten the snorkel body to the fender with body washers (Item 8) and nyloc nuts (Item 9).

Fasten the snorkel body to the upper mounting bracket with hex bolts (Item 4).



Loosen the 90/110mm hose clamp at the air cleaner end and orientate the hose for best alignment.

With the air entry hose correctly installed onto the snorkel body outlet snout and air cleaner inlet adaptor, tighten the 80/100mm hose clamp (item 15) and the 90/110mm hose clamp (item 16).

Note: The orientation of the hose clamp.

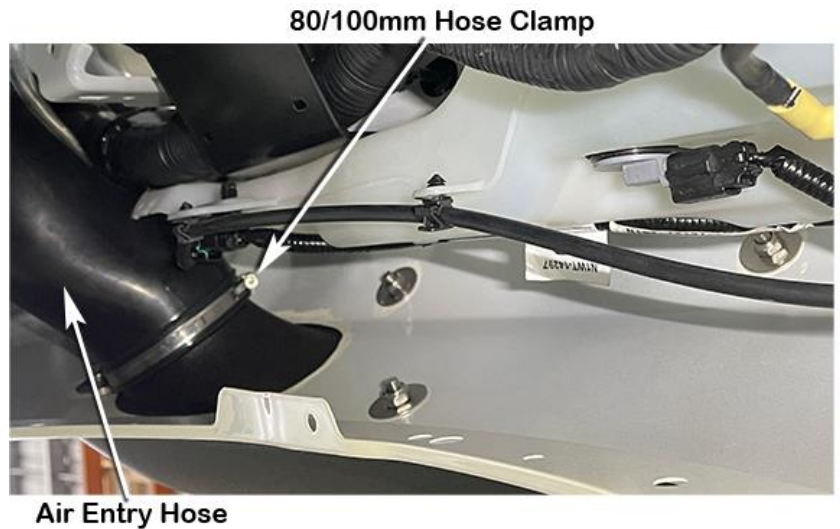

Loosely install the black hose clamp (Item 22) over the base of the air ram assembly (Item 2).

Install the air ram assembly onto the snorkel body.

Align the air ram assembly and tighten the black hose clamp (Item 22).



Re-install the RH Inner guard liner (Secondary Splash Guard Section), Front wheel arch moulding, RH Inner guard liner (Main Splash Guard Section), air cleaner element, air cleaner lid, reconnect sensor wiring and any other items that may have been removed during the snorkel installation process.

N.B: It is the installer's responsibility to ensure that all connections are watertight.