



FITTING INSTRUCTIONS FOR  
Mitsubishi ASX 5DR SUV  
XB Series Released Sep-2012 Onwards  
**For Vehicles Without Rails, Panoramic Moonroof  
and Factory Fitted Sunroof**  
Anchor Point Extended Roof Racks  
PART NUMBER: **APEX122-2**  
FITTING TIME: EST. 30 MINUTES









ROOF-RACK LOADING CAPACITY: **60kgs**

**ISSUE: A**

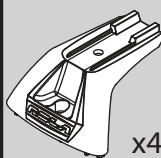
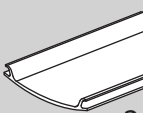
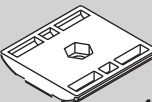

**ISSUE RELEASE DATE: 29/04/13**

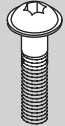
**TOTAL NUMBER OF PAGES INCLUDING COVERSHEET: 5**

## 2. KIT DRAWING AND CONTENTS

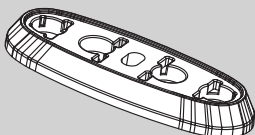
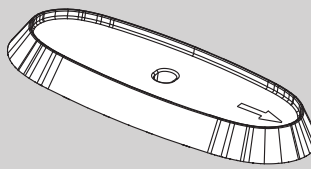
COMMON				
 x4	 x2	 x4	 x4	 x4
END SUPPORT (27-0752)	UNDER-COVER STRIP	SLUG NUT (27-0116)	FLAT WASHER (22-0186)	SPRING WASHER (22-0162)
 x4	 x4	 x4	 x1	
M8 HEX NUT (22-0139)	M8 x 20 HEX BOLT (22-0496)	M6 x 50 STAR BOLT (22-0355)	TT-27 ASSEMBLY KEY (22-0811)	

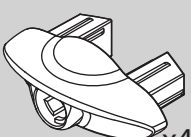
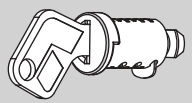
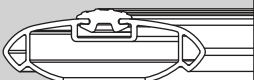
MOUNTS	
	
PLASTIC ADAPTOR BLOCK (27-0717)	ADAPTOR BLOCK GASKET (22-0718)

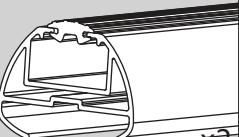
APEX			OR		CAP	
 x4	 x4	 x2	+		 x4	 x2
SPORTS CROSS-BAR END CAP (27-0782)	ROLA LOCK & KEY (22-0600)	SPORTS (RE GLOBAL) CROSS-BAR (10-0020 1250B)	OR		CROSS-BAR END CAP (27-0345)	HEAVY DUTY CROSS-BAR (10-0011 - 1150mm)

## 3. TOOLS AND MATERIALS REQUIRED

				
<b>Cutting Knife</b> - Use to open Kits, and trim Buffer Strip to size.	<b>Measuring Rule</b> - Use to check dimensions and distances of cross-bars.	<b>Cleaning/protective Cloth</b> - Use to wipe down vehicle, and use to protect vehicle paint.	<b>Marking Pencil</b> - Use to mark buffer strip.	<b>13mm Spanner</b> - Use to assemble Cross Bars.

## 4. INSTALLATION STEPS

Prior to Assembly, check that your Roof Rack Box contains all the parts as listed above. Ensure the vehicle roof is clean and dry. Use Knife to cut through the packaging polybags.

Fig 1a

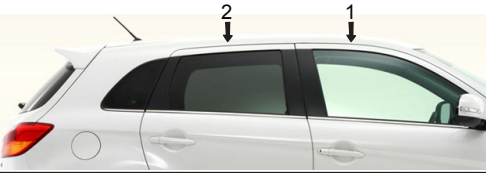

### STEP 1

On the vehicle roof you will find 4 Anchor Point Covers paired in two locations indicated by the arrows in Fig 1a. Carefully remove these covers by sliding in the direction shown on the cover, to reveal the anchor points (Fig 1b). It is advisable to screw the Special Bolts into the Anchor Points at this time to clean the threads.

Fig 1b

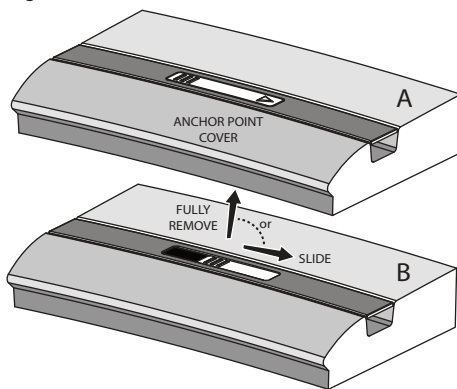

- ⚠ NOTE: Take care when removing to avoid damaging Trim Cover Clip. Covers can not be replaced while rack is fitted.
- ⚠ For a Single-Bar fitment, only remove the two Front or the two Rear covers, depending on the fitment.
- ⚠ Store the Anchor Point Covers and plugs safely while the Roof Racks are in use.

Fig 2a

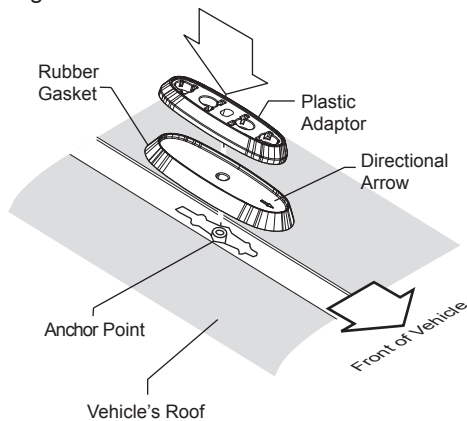

### STEP 2

Replace an Anchor Point Cover, From STEP 1, with one of the supplied Rubber Gaskets

- ⚠ Ensure the Rubber Gasket is oriented correctly (Fig. 2a).
- ⚠ Each Rubber Gasket is marked with a directional arrow (Fig. 2a).
- ⚠ Ensure that the center hole in the gasket lines up with the anchor point thread in the roof.  
For the front anchor point use the forward most threaded point.  
For the rear anchor point use the rearward most threaded point

Locate the Plastic Multi Pad onto the Rubber Gasket

- ⚠ Ensure the Multi Pad is oriented correctly (Fig. 2b).
  - ⚠ Ensure that the center hole in the Multi Pad lines up with the anchor point thread in the roof.
- Repeat for all remaining Adaptors.

Fig 2b

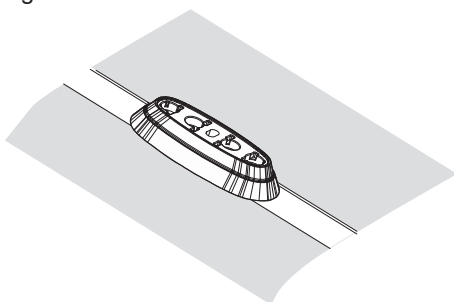

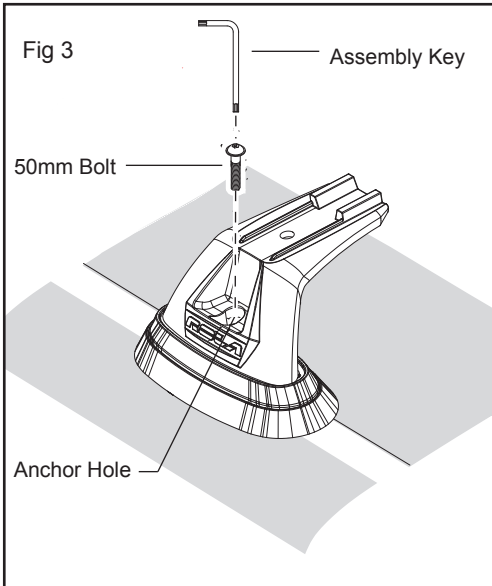

### STEP 3

Place an end support onto the adaptor from STEP 2, and loosely secure it down with a 50mm bolt by inserting the bolt into the anchor hole, and turning approximately 2-3 turns with the security key (Refer to Fig. 3). Do not tighten yet. Repeat for the opposite side.

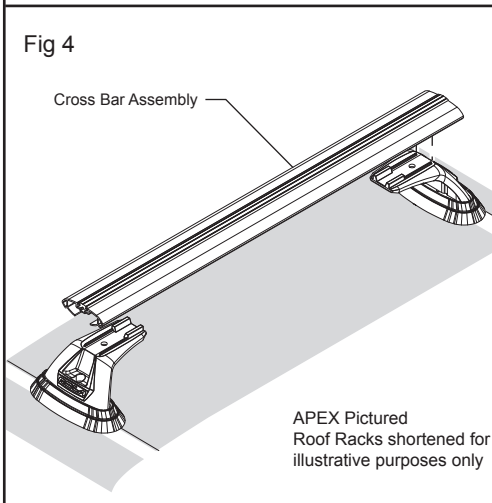
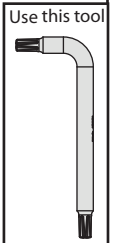

### STEP 4

Place the crossbar onto the end supports ensuring that the end supports are located into the cutouts on the underside of the crossbar. (Fig. 4)

Check that the cross bar has equally distanced overhang on either side from the end support.

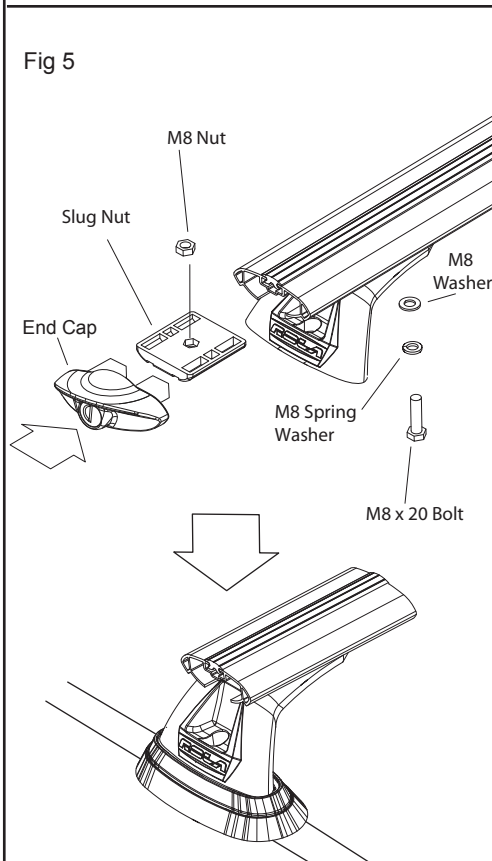

### STEP 5

Insert the M8 nut into the cavity on the Commercial Slug. (Fig. 5)

Insert the Commercial Slug into the cross tube, and align it so that the M8 nut in the Commercial Slug and the hole at the bottom of the end support line up.

Secure the cross bar to the end support by screwing the M8x20mm bolt through the hole in the end support and up into the nut that is located in the cavity of the Commercial Slug nut.

Using a 13mm Spanner, fully tighten the 20mm bolt on the underside of the end support.

Tighten M8 bolts to 6-7 Nm  
Tighten M6 bolts to 5-6 Nm

Repeat Step 6-7 for remaining crossbar.  
Refer to fitting instruction 424 for insertion of the under-cover strip.

Fig 8

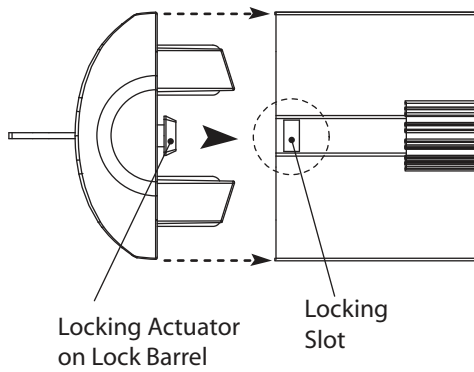

**STEP 8** *Note: Only APEX has locking capability*

Pull back the buffer strip to allow access to the end of the cross-bar.  
 Insert Endcap into the Cross-bar by locating the two 'feet' of the Endcap into the void inside the cross-bar. (Fig 8)

Push through until End-cap edge comes to rest against the edge of the cross-bar. This is important as the Locking Actuator inside the Endcap has to locate within the Locking slot on the end of the cross-bar.

Fig 9

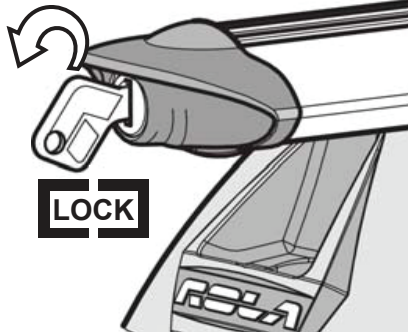

**STEP 9**

Pull back the buffer strip to allow access to the end of the cross-bar.

Fig 10

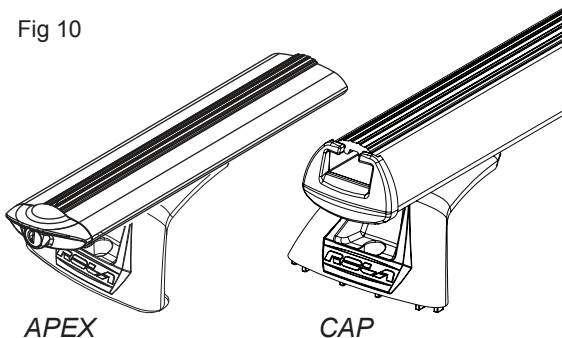

**STEP 10**

You are now ready to mount your accessories, eg. Bike Carrier, Kayak carrier, etc. utilising the "Global Channel" if applicable. (Fig. 9).

Place the accessory onto the buffer strip in the location where it will be mounted in relation to your cross-bars. Using a marking and measuring tool, ie. pencil/tape measure - make your mark onto the rubber buffer strips.

Next, completely remove the buffer strip from its channel within the cross-bars and cut out the portion using heavy duty scissors/shears.

NOTE: DO NOT dispose of this rubber strip but store it in a secure place to be re-mounted once the accessory has been removed from the rack. This will help reduce wind noise during travel.



**USAGE INSTRUCTIONS**

It is essential for the proper assembly, operation and use of the Roof-rack that the instructions and safety precautions supplied are strictly observed. The Maximum permissible load for your Roof Bar is the lower of the maximum load capacity specified in you vehicle operation manual, or specified as applying to the Roof-rack. Do not exceed the maximum specified Load capacity.

Maximum Permissible Load = Weight of the Roof-rack + Weight of Accessories + Weight of Load(Cargo).

When fitting the Roof-rack and transporting a load, ensure the vehicle's functions are not impaired (eg. sunroof, aerials, windscreen wipers, mirrors). Rear doors on Hatch - and wagon-type vehicles should be inspected for adequate clearance for full opening operation of the boot/tailgate.

Stop and check all screw connections, bolts and retaining straps after a short distance of travel. Repeat these checks at regular intervals.

**WARNINGS**

Remember that the fitting of a Roof-rack and the transport of a load increases the overall height of the carrying vehicle.

Where the roof-rack is to be used in off-road conditions, a safety weight reduction of 1.5 should be observed from the total carrying capacity (eg. 60kg becomes 40kg).

Cequent will not be liable to the purchaser of any other person for any consequential, direct or indirect loss, damage or costs incurred or suffered by the purchaser or any other person including but not limited to damage to persons or property, loss of turnover, loss of profits, loss of business or goodwill arising from or in relation to the assembly and use of the Roof-rack, or the non-observance of the fitting and care instructions.