



SIDE STEP ROADRUNNER

FITTING INSTRUCTIONS



MITSUBISHI TRITON 2019

PK407BCPMT19DC

PK407SCPMT19DC

Fitting Time : approx. 1 hours



SIDE STEP SAFETY NOTICE:

INSTALLATION SHOULD ONLY BE DONE BY APPROPRIATELY QUALIFIED OR EXPERIENCED PERSONS IN ACCORDANCE WITH THESE INSTRUCTIONS.

IT IS THE RESPONSIBILITY OF THE INSTALLER TO ENSURE THAT THE PRODUCT IS CORRECTLY FITTED.

WARNING:

Do not attach Vehicle Frontal Protection System (**VFPS**) to the vehicle using anchorages not intended for this purpose. (e.g. engine mounting bolts)

Do not use this product for any vehicle make or model, other than those specified by the VFPS manufacturer.

Do not remove the plaque or label from the VFPS.

Do not modify the structure of the VFPS in any way.

The VFPS has been produced to provide continued functionality of parking sensors and other "driver assist" features as closely as possible to Original Equipment. However, as all possible road conditions and combination of other accessories fitted to the vehicle which may affect functionality characteristics cannot be anticipated, ***the driver remains responsible at all times for properly controlling the vehicle, monitoring all "driver assist" features and intervening where required to ensure the vehicle is safely operated.***

IMPORTANT INFORMATION:

Before installing the VFPS:

Check that all components, as listed in the assembly table, are available.

Thoroughly read all instructions.

This product or its fasteners must not be modified in any way.

These instructions are accurate as at the revision date and do not take into account any changes made by the vehicle manufacturer to vehicle design after the revision date or other accessories that are or have been fitted to the vehicle. Piak cannot be held responsible for such changes and appropriate enquiries should be made before installation.

Before installing, inspecting and/or maintaining the VFPS, the work space should be safe and clear of fuel, debris, electrical or other components.

During installation:

It is the responsibility of the installer to confirm correct operation/clearance of all components.

All holes drilled shall have all burrs and swarf removed then coated with a suitable rust preventative paint.

Ensure that all hardware is fastened to torque list as detailed in these instructions.

MAINTENANCE AND CARE:

To ensure continued safety and correct operation of the product, the VFPS must be routinely inspected and regularly serviced (including bolt torque checked for correct tension) by an appropriately qualified or experienced person.

The high tensile fasteners supplied with this product were used to achieve the specified rating. If replacement of the fasteners is required, fasteners of the same rating and quality must be used.

If this VFPS is fitted with a hinged number plate bracket, extra care must be taken when returning back to public roads following the use of the winch or conducting a deep water crossing.

The driver must ensure that the number plate bracket is returned back to the down position allowing full visibility of the number plate when returning to public roads.

EQUIPMENT:

These safety products should, at a minimum, be used when fitting or working on the product.



Protective Glasses



Hearing Protection

Installation in accordance with these instructions and adherence to warnings will ensure compliance with relevant regulatory and safety standards as at the revision date.

Failure to adhere to these instructions may affect the roadworthiness of the vehicle or cause personal injury, death or damage to property.

BY USING THIS PRODUCT YOU ACKNOWLEDGE AND AGREE THAT TO THE EXTENT PERMITTED BY LAW PIAK WILL NOT ACCEPT LEGAL OR OTHER LIABILITY FOR ANY LOSS, INJURY OR DAMAGE CAUSED BY INCORRECT OR INAPPROPRIATE INSTALLATION OR USE OF THE PRODUCT.

TOOLS REQUIRED

1. Torque , Socket wrench
2. Screw driver
3. Open spanner

PARTS LIST

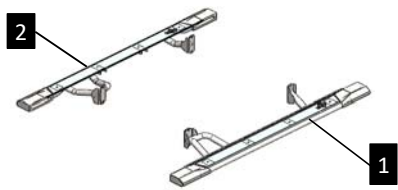
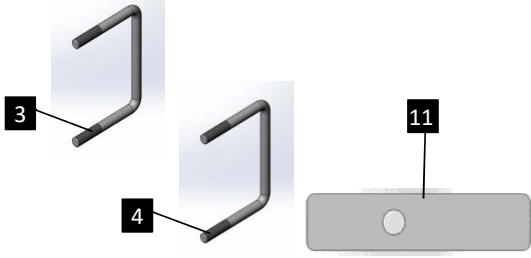

Important : Check contents of fitting kit before commencing fitment and report any discrepancies.

Steel Side Step				
Item	Component Name	Q'ty	Remarks	
1	Side Step (LH)	1		
2	Side Step (RH)	1		
Connector Side Step				
Item	Component Name	Q'ty	Remarks	
3	U-Bolt M12x1.5x154x105	2		
4	U-Bolt M12x1.5x144x118	2		
5	Spring washer M12	8		
6	Flat washer M12 OD33	8		
7	Hex nut M12x1.5	8		
8	Hex Bolt M8x35x1.25	2		
9	Flat washer M8 OD20	2		
10	Spring washer M8	2		
11	Fuel Line Spacer 20x90x6T	2		

Component overview

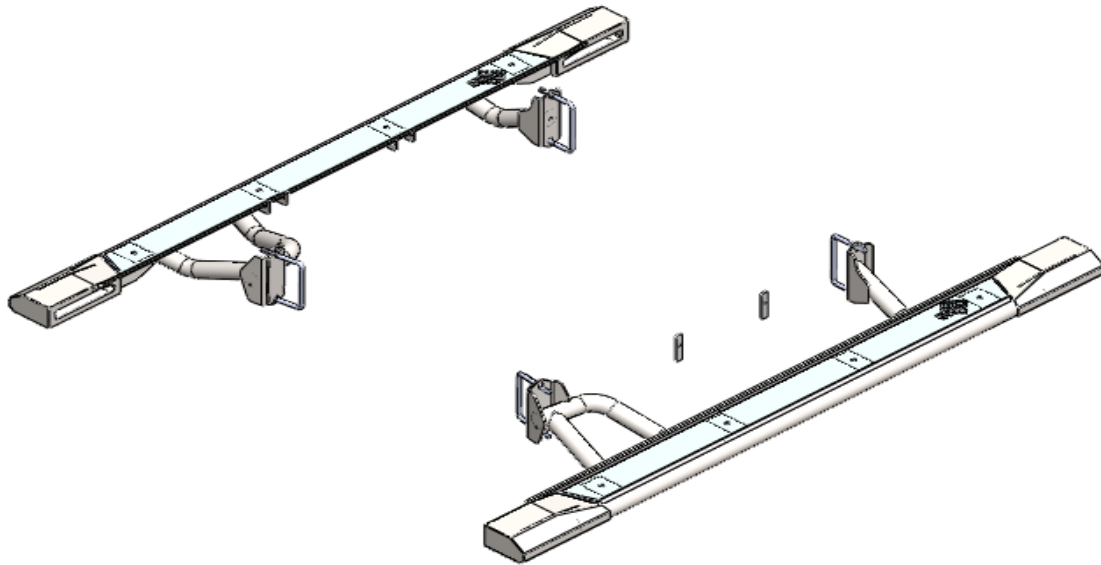

TORQUE SETTING OF FASTENER

Mounting bolts must be tightened to torque's specified following ;

Bolt Diameter (mm.)	Torque (Nm)	Torque (ft.lb)
M6	9	7
M8	22	16
M10	44	32
M12	77	57

FITTING PROCEDURE



- 1 Locate the vehicle in a suitable area.

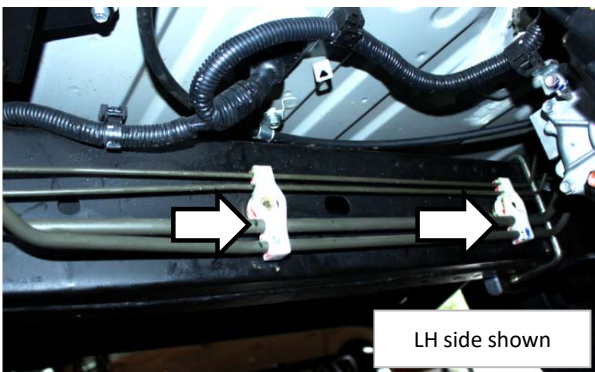

- 2 Remove and discard two screws securing fuel line brackets on LH chassis rail of vehicle as shown.

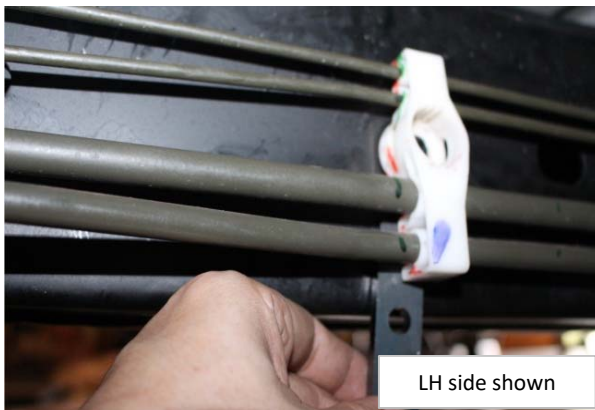

- 3 Insert fuel line spacer between the chassis rail and either bracket.



- 4 Secure with two supplied M8 bolts (M8x30x1.25), spring and flat washers.

FITTING PROCEDURE

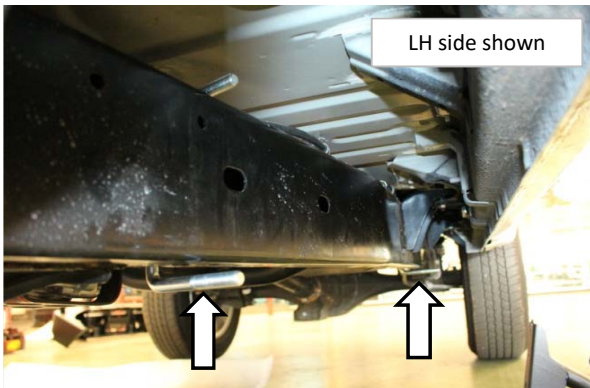

- 5 Fit two U-Bolts onto the LH chassis of vehicle as shown.



- 6 Fit the U-bolts on the inside of the chassis behind any hoses or wiring.



- 7 Lift the LH side step onto the chassis of vehicle.



- 8 Secure the side step to the U-bolts using M12 bolts, spring and flat washers.

FITTING PROCEDURE

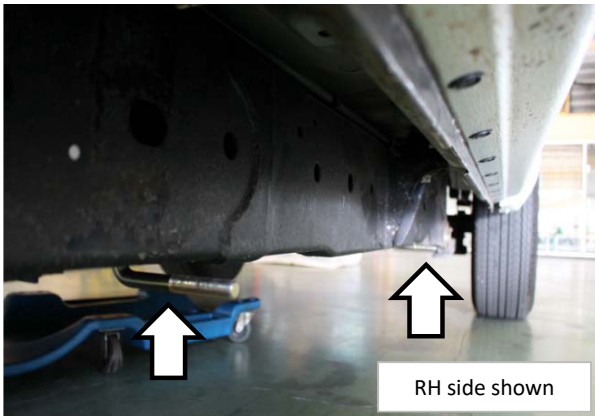

- 9 Fit two U-Bolts onto the RH chassis of vehicle as shown.



- 10 Lift the RH side step onto the chassis of vehicle and secure the side step to the U-bolts using M12 bolts, spring and flat washers.

