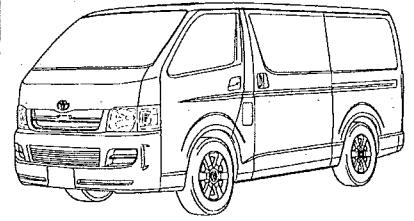


KEEP THE FEELING!

**TOYOTA GENUINE**

PARTS, SERVICE & ACCESSORIES

**Hi-Ace 6.0– Narrow Van**  
**CARGO BARRIER**  
**Installation Instructions**  
 Jan 05 Onwards-



Accessory Part No. PZQ72 75010

Installation Time: Approx 1hr

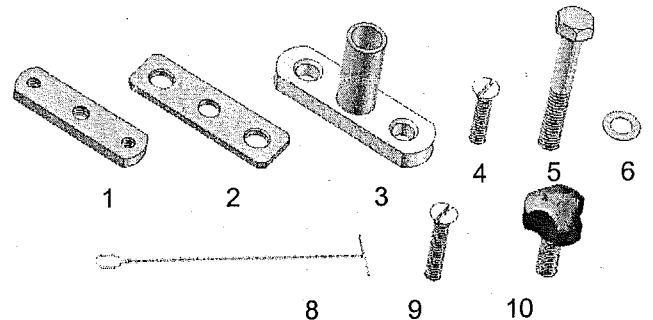
Place these instructions in the vehicles glove box after installation is complete

**IMPORTANT:** The installation kit contains sufficient components to fit the cargo barrier. A high degree of technical competence is necessary to correctly install this product. We recommend this Cargo Barrier be installed by a Toyota Dealer to ensure the barrier installation complies with AS/NZS 4034.1 Standard. These instructions must be read and clearly understood before commencing installation. Strict compliance with installation instructions is essential for this safety product to meet its rated capacity.

**Parts List**

**Important:** Check contents of kit before commencing fitment and report any discrepancies.

Item	Component Name	Part No.	Qty
1	Mounting Plate	<b>PZQ7275010FK</b>	4
2	Cover Plate		2
3	Cover Plate Assy		2
4	5/16 x 1" CSK Screws		4
5	M10 x 60mm Hex Head Bolt		2
6	3/8 Crinkle Washer		4
7	Tekote Rust Preventative (Not Shown)		1
8	Installation Tool		2
9	5/16 x 1 1/4" CSK Screws		4
10	M10 x1.5x 24mm Milbolt		2



**TOOLS REQUIRED**

- Hammer
- Screwdriver
- Drill
- Masking Tape
- Marker
- Centre Punch
- 5mm, 9mm, 11mm Drill Bits
- 22mm Hole Saw
- Drill stops
- 16mm, Vinyl Cutters
- Tape Measure
- Steel Rule

**FITTERS ADVICE**

- Note:** To fit the Cargo Barrier the following is essential:
- Always drill perpendicular to surface (Unless stated otherwise).
  - A positive drill stop should always be used to prevent accidental damage to external panels, fuel lines etc.
  - A vinyl cutter assembly should be used for all soft material (i.e. Hood lining, floor covering etc). This can be made by grinding the teeth from a hole-saw at an angle of about 45 degrees.
  - Care should be taken when applying Tekote Sealer/Rust Preventative to all holes drilled to negate the possibility of skin and eye irritation.
  - Check screws in relevant components by hand before installation. Should there be resistance re-tap threads and re-check.
  - Before marking or drilling for this Cargo Barrier, check vehicle for LPG Conversion. If LPG is fitted, locate gas unit and all lines attached and take EXTREME CARE whilst installing this Cargo Barrier.**

**CARE SHOULD BE TAKEN NOT TO CROSS THREAD THE FASTNERS DURING INSTALLATION OF COMPONENTS TO THE VEHICLE.**

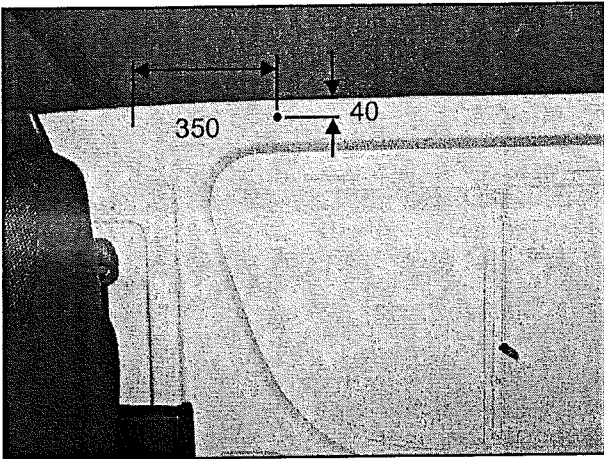


Diagram 1: Top drivers side mount location.

**1. TOP RIGHT HAND MOUNT LOCATION.**

- Mark location accordingly to picture with felt pen.

**Important:** Take 350mm measurement from rib that separates soft trim and timber roof panel.

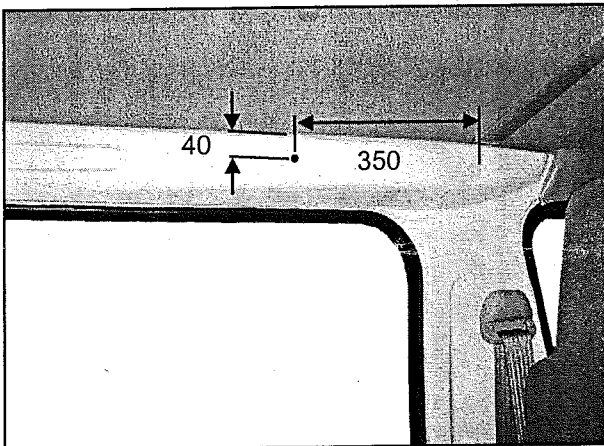


Diagram 2: Top passenger side mount location.

**2. TOP LEFT HAND MOUNT LOCATION.**

- Mark location accordingly to picture with felt pen.

**Important:** Take 350mm measurement from rib that separates soft trim and timber roof panel.

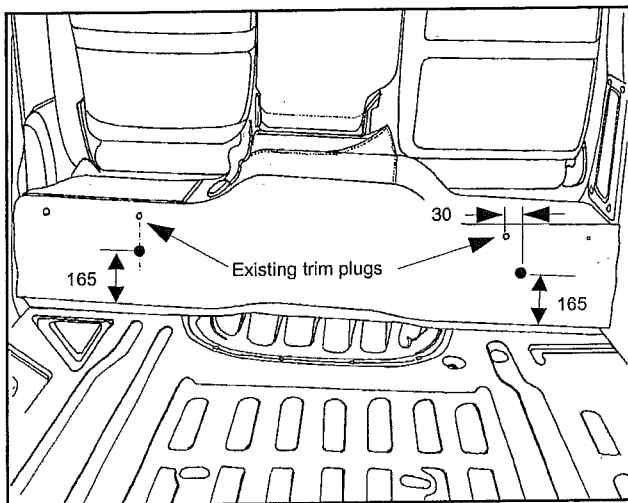


Diagram 3: Bottom mount locations in firewall.

**3. BOTTOM MOUNT LOCATIONS.**

- Mark location accordingly to picture with felt pen.

**Important:** Take each measurement from centre of existing trim plugs.

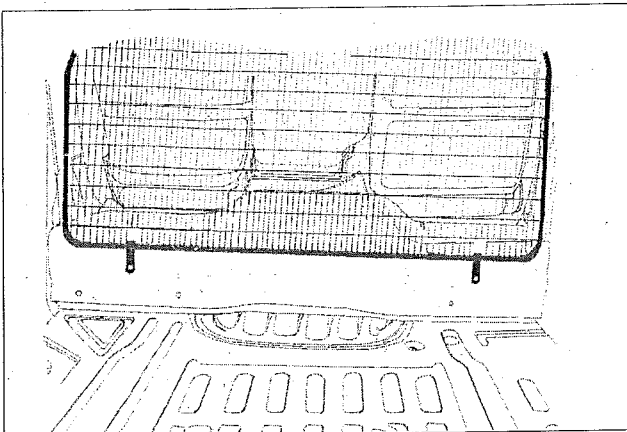


KEEP THE FEELING!



**TOYOTA GENUINE**

PARTS, SERVICE & ACCESSORIES

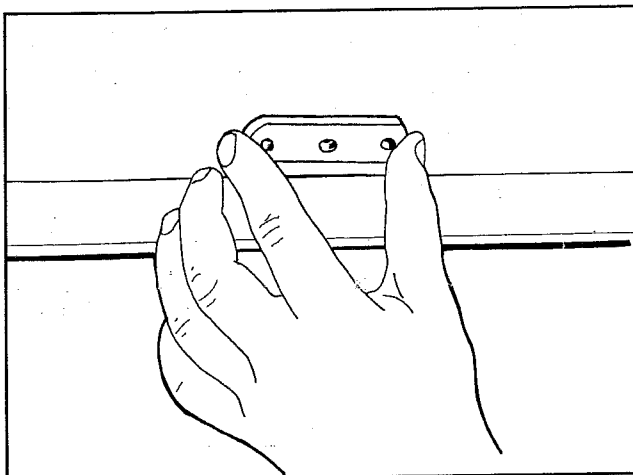


**Diagram 4:** Check all marked points with position of straps.

#### **4. CHECK LOCATIONS.**

- Place Cargo Barrier into position and check against marked locations.

**Important:** Do not drill holes until marked locations are confirmed.

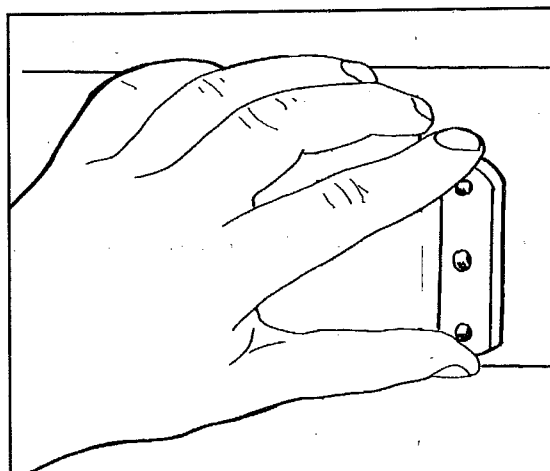


**Diagram 5:** Marking outer holes with Mounting Plate.

#### **5. MARK MOUNTING PLATE OUTER HOLES FOR TOP MOUNTS.**

- Place centre hole of Mounting Plate over marked location's from step's 1 and 2.
- Mark outer holes with Mounting Plate (Item 1) with felt pen.

**Important:** Mark outer holes parallel with sides of vehicle.



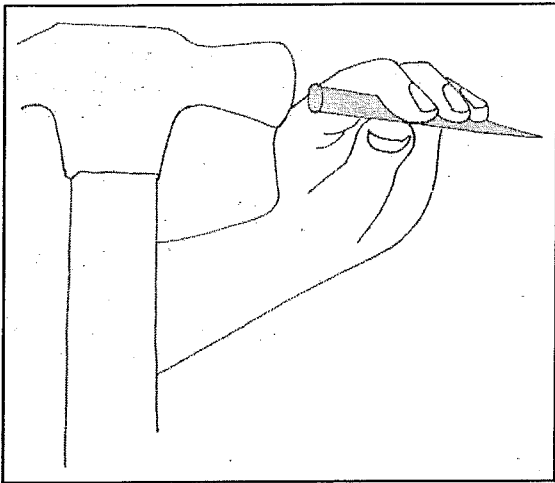
**Diagram 6:** Marking outer holes with Mounting Plate.

#### **6. MARK MOUNTING PLATE OUTER HOLES FOR BOTTOM MOUNTS.**

- Place centre hole of Mounting Plate over marked location's from step 3.
- Mark outer holes with Mounting Plate (Item 1) with felt pen.

**Important:** Mark outer holes vertical up face of firewall.



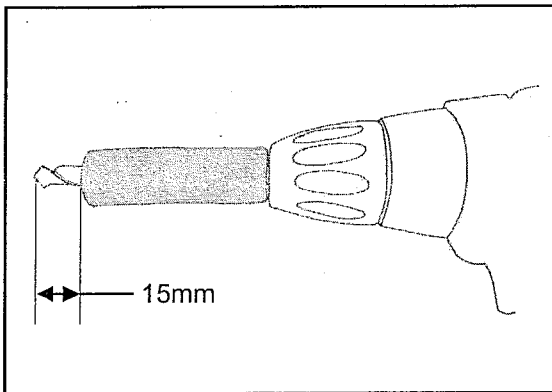


**Diagram 7:** Centre punch all marked locations.

### 7. CENTRE PUNCH.

- Centre punch all marked location points top and bottom.

**Important:** Centre punch through soft trim so metal panels are marked.

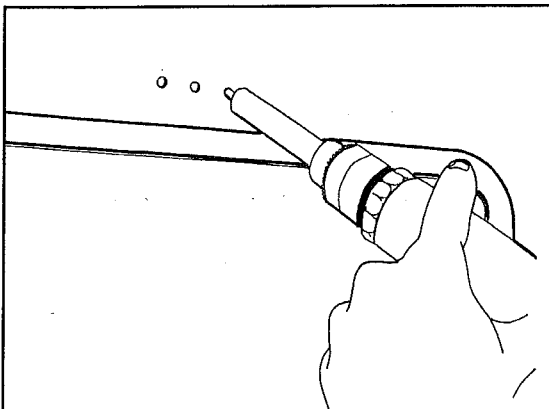


**Diagram 8:** Drill stop settings.

### 8. SETTING DRILL STOP LENGTH.

- Set Drill stop length as shown in picture.

**Important:** Set Drill stop so outer panels or batteries behind panels do not get damaged.



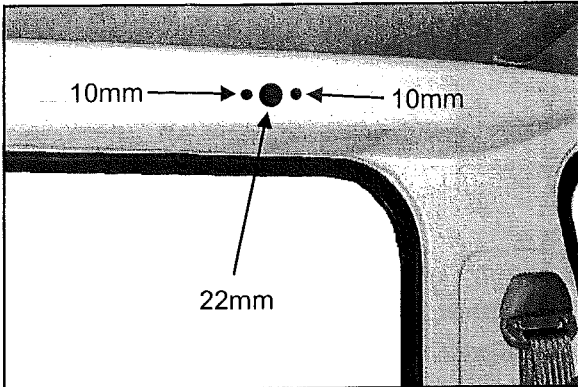
**Diagram 9:** Drilling 5mm pilot holes in top panel shown.

### 9. DRILLING PILOT HOLES

- Drill 5mm pilot holes at all marked points.

**Important:** Drill perpendicular to all surfaces. Caution should be taken when drilling bottom mounts as battery is behind panel.



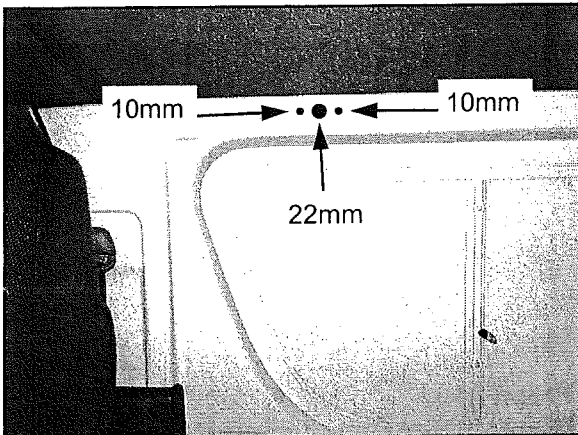


**Diagram 10:** Passenger side top mount hole sizes.

**10. DRILLING TOP MOUNTS PASSENGER SIDE.**

- Drill out holes as shown in picture.

**Important:** Caution should be taken not to drill through outer panels.

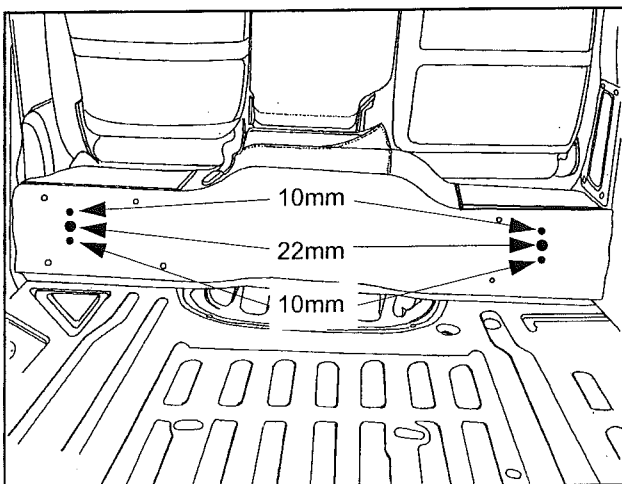


**Diagram 11:** Drivers side top mount hole sizes.

**11. DRILLING TOP MOUNTS DRIVERS SIDE.**

- Drill out holes as shown in picture.

**Important:** Caution should be taken not to drill through outer panels.



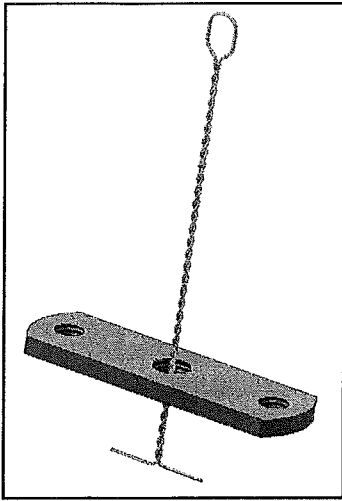
**Diagram 12:** Bottom mount hole sizes.

**12. DRILLING BOTTOM MOUNTS.**

- Drill out holes as shown in picture through metal panel.

**Important:** Caution should be taken as a battery is present behind panel. Battery may need to be taken out whilst installing mounts.

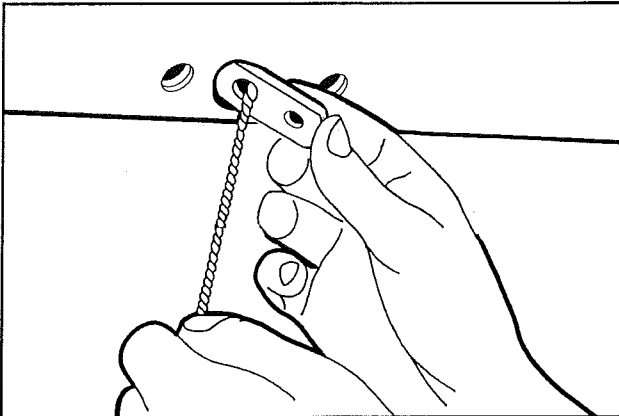




**Diagram 13:** Assembly of Installation Tool and Mounting Plate.

**13. ASSEMBLY OF INSTALLATION TOOL AND MOUNTING PLATE.**

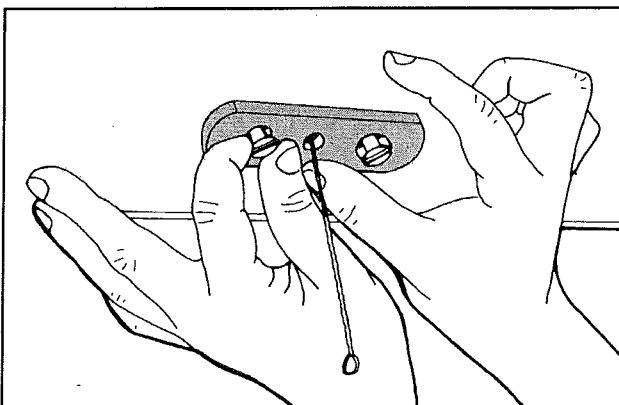
- Push eye of Installation Tool through centre hole of Mounting Plate as shown in picture.



**Diagram 14:** Inserting mounting plate.

**14. INSERTING MOUNTING PLATE FOR TOP MOUNTS.**

- Insert Mounting Plate through centre 22mm holes drilled in step's 10 and 11 as shown in picture.



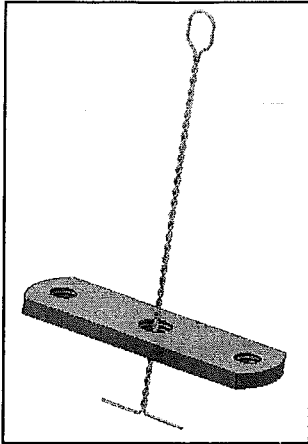
**Diagram 15:** Attaching Cover Plate to Mounting Plate.

**15. COVERPLATE ASSEMBLY TOP MOUNTS.**

- Slide centre hole of Cover Plate over eye of Installation Tool.
- Hold Cover Plate in position with end holes lined up with those of the Mounting Plate behind the metal panel.
- Attach outer holes using 5/16 x 1" CSK Screws.
- Repeat for other side.

**Important:** Ensure M10 x 1.5 centre thread is aligned correctly.

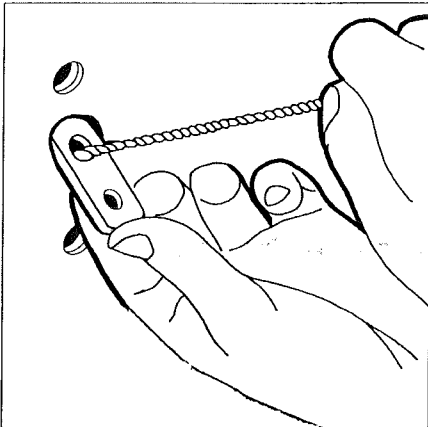




**Diagram 16:** Assembly of Installation Tool and Mounting Plate.

### 16. ASSEMBLY OF INSTALLATION TOOL AND MOUNTING PLATE.

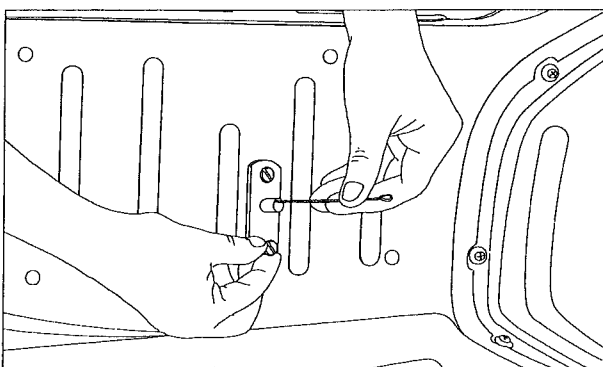
- Push eye of Installation Tool through centre hole of Mounting Plate as shown in picture.



**Diagram 17:** Inserting mounting plate.

### 17. INSERTING MOUNTING PLATE FOR BOTTOM MOUNTS.

- Insert Mounting Plate through centre 22mm holes drilled in step 12 as shown in picture.



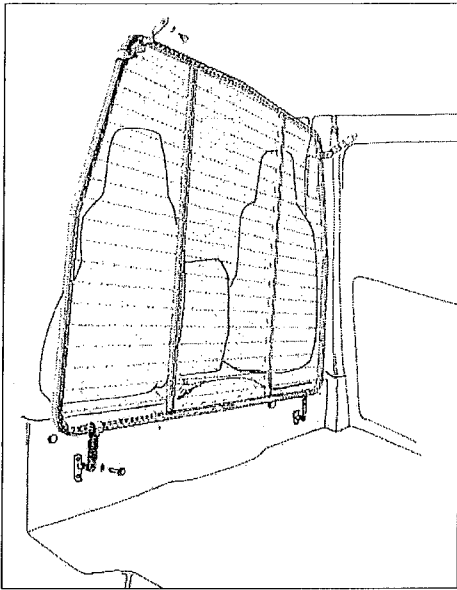
**Diagram 18:** Attaching Cover Plate to Mounting Plate.

### 18. COVER PLATE ASSEMBLY BOTTOM MOUNTS.

- Slide centre hole of Cover Plate Assy with spacer tube facing outward over eye of Installation Tool.
- Hold Cover Plate Assy in position with end holes lined up with those of the Mounting Plate behind the metal panel.
- Attach outer holes using 5/16 x 1 1/4" CSK Screws.
- Replace vinyl covering and cut out a 22mm hole where the spacer tube protrudes through the vinyl.
- Repeat for other side.

**Important:** Ensure M10 x 1.5 centre thread is aligned correctly.



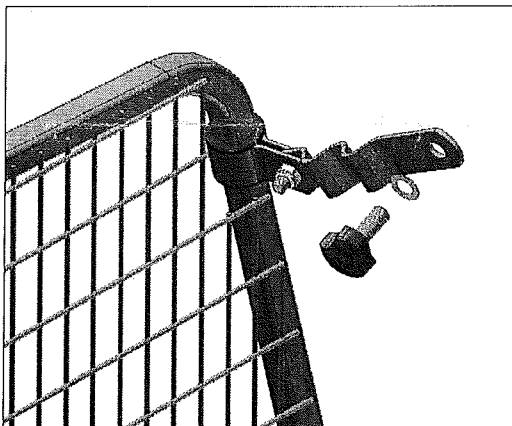


**Diagram 19:** Place Cargo Barrier Panel in position.

### 19. POSITION CARGO BARRIER.

- Stand Cargo Barrier Panel in position as shown in picture.

**Important:** The Cargo Barrier's compliance plate must be in the centre of the barrier and facing toward the front of the vehicle.

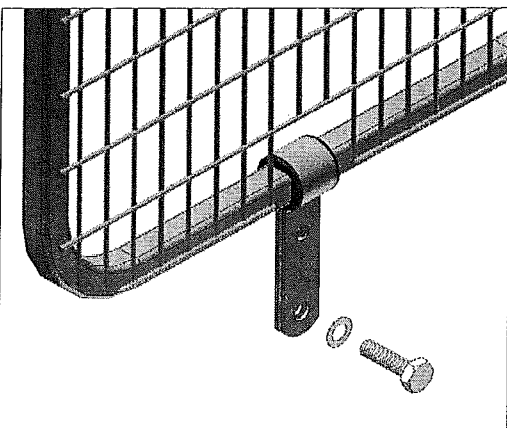


**Diagram 20:** Attaching top straps to vehicle

### 20. TOP MOUNT ATTACHMENT.

- Attach top straps to mounts using M10 x 24mm Milbolts and 3/8 Crinkle Washer as shown in picture.

**Important:** Check that all nuts, bolts and screws are tight and re-check periodically.



**Diagram 21:** Attaching bottom straps to vehicle.

### 21. BOTTOM MOUNT ATTACHMENT.

- Attach bottom straps to mounts using M10 x 60mm Hex Head Screws and 3/8 Crinkle Washer as shown in picture.

**Important:** Check that all nuts, bolts and screws are tight and re-check periodically.

